Table of Contents

Introduction to DSC

Subject	Page
Module Objectives.....	2
Overview of DSC Systems	3
Purpose of the System	4
DSC Components	9
Control Module/Hydraulic Unit.....	10
Wheel Speed Sensors	11
Hydraulic Pressure Sensor	12
Steering Angle Sensor	13
Rotation Rate Sensor	14
Lateral Acceleration Sensor	16
Combined Rotation Rate/Lateral Acceleration Sensor	17
DSC Switch	18
Handbrake Switch	18
Brake Switch	18
Hydraulic System Components	19
Principle of Operation	24
Diagnosis	29
Review Questions	31

Model: 1995-1997 E38 750iL, E31 850Ci with DSC II
1998 E38 740i/iL and 750iL, E39 540i with DSC III 5.3
1999-Present E38 740i/iL and 750iL, E39 540i and 528i with DSC III 5.7

Production: All E38 and E39 with Bosch 5.7 DSC III

Objectives:

After completion of this module you should be able to:

- Understand Basic DSC operation.
- Identify Components within the DSC System (DSC 5.3 and DSC 5.7).
- Locate Components within the DSC system.
- Understand the differences between ASC and DSC.
- Understand Differences between Bosch DSC 5.7 and 5.3.

Overview of DSC Systems

Model Year	E36	E36/7 Z3	E46	E39	E38	E53	E52	E65 E66	E85
1998	ASC+T	ASC +T MK IV G	N/A	9/97 ASC +T5 S: 528i DSC III 5.3 S: 540i N/A 528i	9/97 DSC III Bosch 5.3 S: 740i/iL S: 750iL	N/A	N/A	N/A	N/A
1999	ASC + T MK IV G 328iC 318ti	ASC + T MK 20 EI (Except M) ASC + T Mk IV G (M Versions)	ASC Teves MK 20 EI	9/98 ASC + T5 S: 528i Bosch DSC III 5.7 S: 540i O: 528i	3/98 Bosch DSC III 5.7 S: 740i/iL S: 750iL	N/A	N/A	N/A	N/A
2000	N/A	from 4/99 Teves MK 20 DSC III	DSC III Teves MK 20 EI from 6/99	6/99 Bosch DSC III 5.7 STD All	3/99 Bosch DSC III 5.7 STD All	DSC III B o s c h 5.7 9/99	DSC III B o s c h 5.7 1/00	N/A	N/A
2001	N/A	From 9/00 Teves MK 60 DSC III M Versions Teves MK 20 DSC III	DSC III Teves MK 60 from 9/00 M3 Teves MK 20 E46/16 AWD Bosch DSC III 5.7	DSC III Bosch 5.7	DSC III Bosch 5.7	DSC III B o s c h 5.7	DSC III B o s c h 5.7	N/A	N/A
2002	N/A		Same as 2001	DSC III Bosch 5.7	N/A	DSC III B o s c h 5.7		DSC III Bosch 5.7	N/A
2003	N/A	N/A	Same as 2001	DSC III Bosch 5.7	N/A	DSC III B o s c h 5.7	DSC III B o s c h 5.7	DSC III Bosch 5.7	DSC III Teves MK60

S = STANDARD EQUIPMENT
O = OPTIONAL EQUIPMENT
STD All = Standard All Models

Dynamic Stability Control (DSC II/DSCIII)

Purpose of the System

DSC adds a further dimension to the traction control system. DSC adds lateral control to this already proven system. The traction control system was designed for longitudinal stability and providing the optimum traction for driving off.

DSC II has the ability to mildly correct for lateral instability and only at the rear brakes when braking control is necessary.

DSC III has the ability to brake any wheel during cornering maneuvers where the control module's programmed limits for vehicle oversteer and understeer are exceeded.

The DSC II system monitors the input values from the two front wheel speed sensors and the steering angle sensor. The rotational speeds of the front wheels for the given turning angle are compared to the programmed values in the DSC control module. If the values are outside the programmed limits, DSC regulation will be activated.

New sensors are added to the DSC III system to monitor the rotational rate of the vehicle around its vertical axis and a lateral acceleration sensor to monitor the side to side forces on the vehicle.

On DSC II or DSC III systems, the control regulation follows the same outputs as for traction control regulation with:

- Throttle valve regulation
- Engine intervention
- Rear brake control

The control phases are brief and only occur long enough to correct the unstable condition.

The following text in this training manual will focus on Bosch DSC III 5.3 and 5.7. The Bosch DSC II system is an enhancement to the existing ASC+T5 system already in use. The DSC II system is identical to ASC+T5 with the addition of the steering angle sensor and the DSC control unit.

Dynamic Stability Control (DSC II)

Dynamic Stability Control II (DSC II) is a further development to the ABS/ASC+T5 traction control system. DSC I was introduced in other markets on the E32 and E31 vehicles with the M70 engine.

The DSC system is designed to improve the lateral stability of the vehicle in all driving situations. Whereby ASC+T is primarily designed for longitudinal stability and providing the optimum traction for driving off, DSC adds lateral stability control to the already proven system.

For any given turning angle and speed of the vehicle, there is a set difference between the rotational speeds of the front wheels. If the rotational speeds of the front wheels vary from this set difference, it means the vehicle is understeering or oversteering through the turn. This could lead to an unstable condition and possible loss of control.

The DSC system is designed to monitor this rotational difference and react to any changes or deviations that might possibly occur. The DSC provides ASC control for the vehicle while driving through corners or any time the vehicle is not moving straight ahead.

In essence, the ASC+T5 becomes a Dynamic Stability Control System with this added feature.

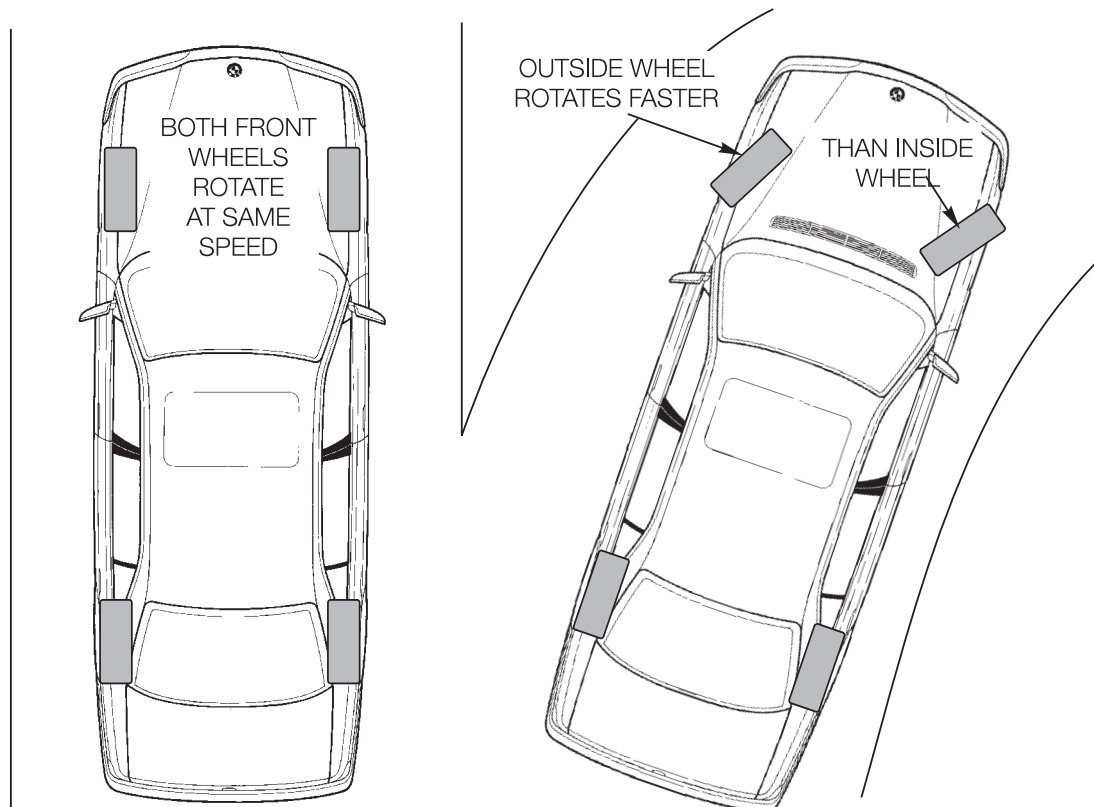

DSC II

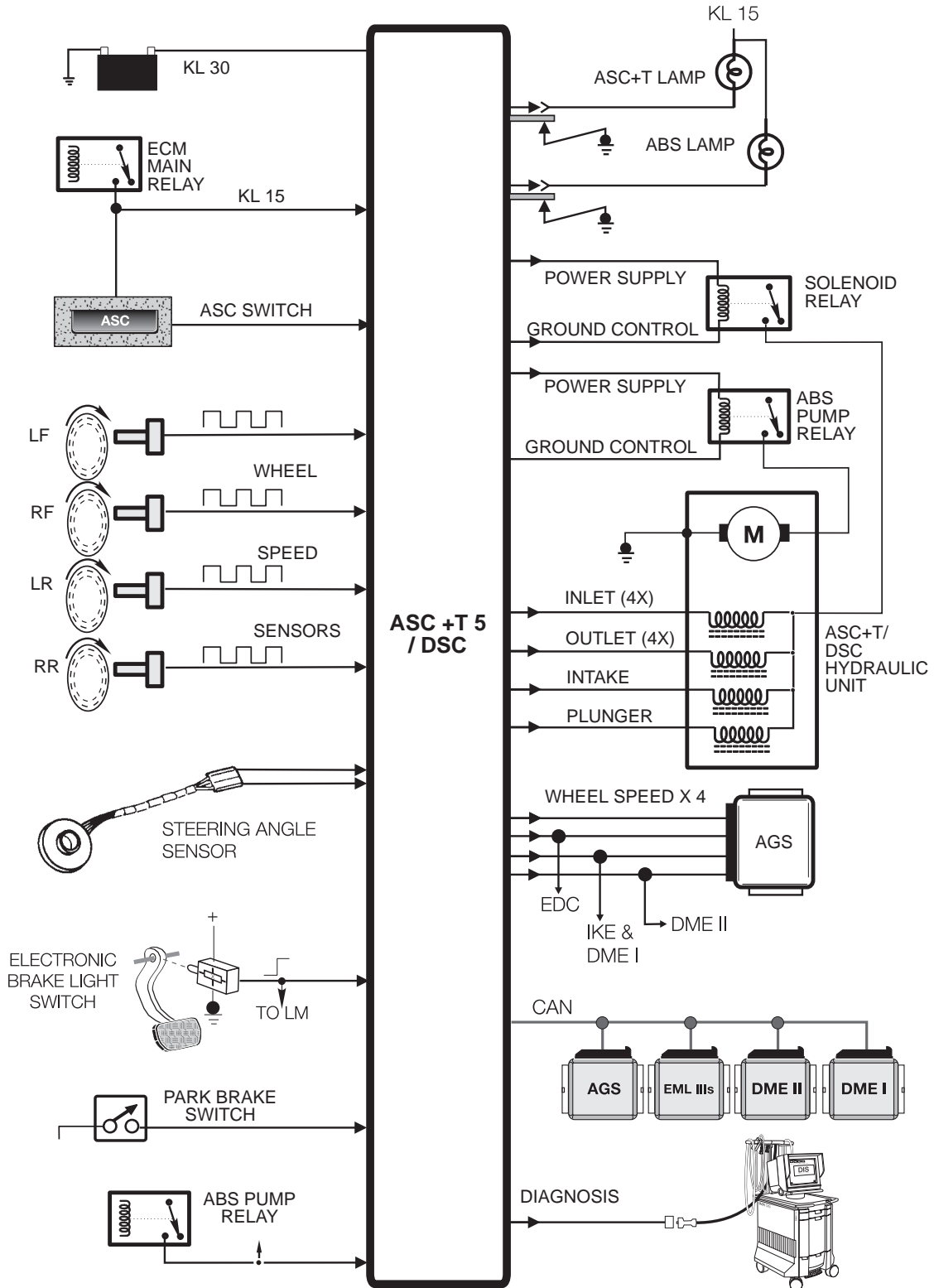

Bosch 5. 3 DSC III I-P-O

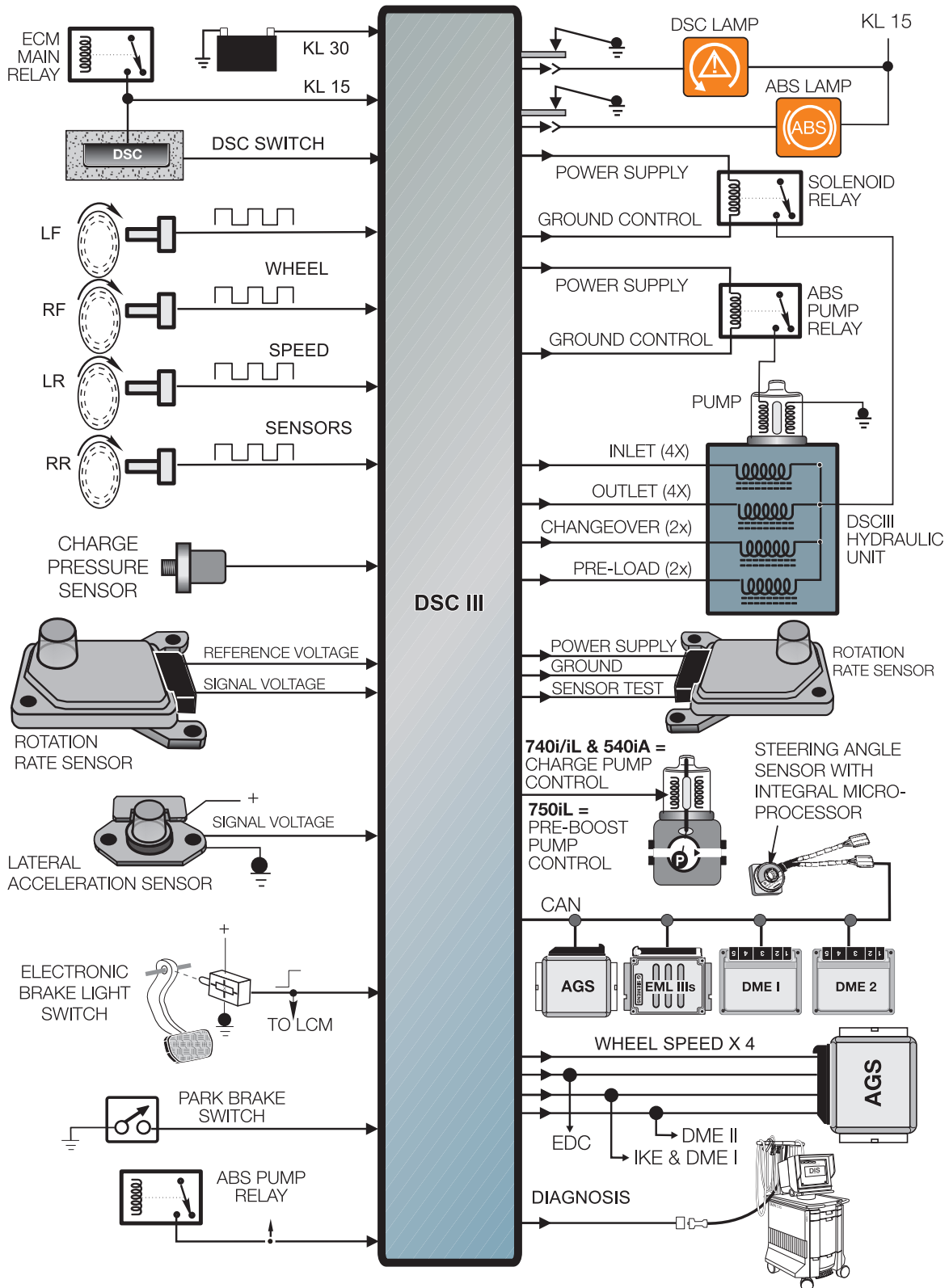

DSC III (Bosch 5.7) IPO

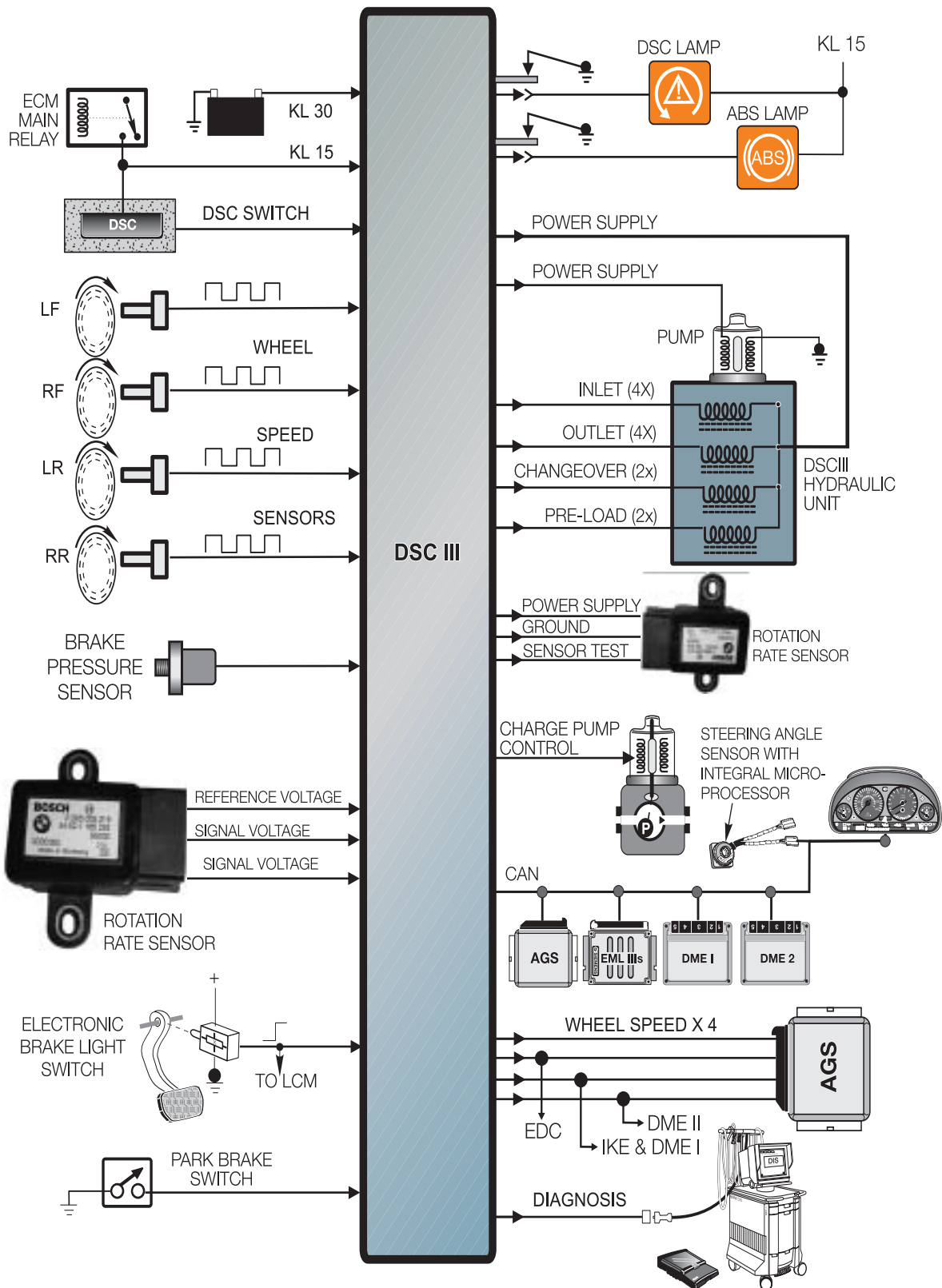

DSC III 5.3 Components

The Bosch DSC III 5.3 System consists of the following components:

- DC III Control Module 83 Pin
- Wheel Speed Sensors (Active Hall Effect)
- Hydraulic Pressure Sensor
- Steering Angle Sensor
- Rotation Rate (Yaw Sensor)
- Lateral Acceleration Sensor
- DSC Switch
- Hand Brake Switch
- Brake Switch
- Pre-Charging Pump
- Hydraulic Unit
- Charging Piston (750iL only)

BOSCH DSC III 5.7 COMPONENTS

With the exception of the following, all components of the DSC - 5.3 are carried over and their functional operation remains the same.

- Control Module/Hydraulic Unit - Control Module and hydraulic unit have been combined into one assembly. The unit now includes the hydraulic unit, control module and return pump.
- Rotational Rate/Lateral Acceleration Sensor - These two sensors have been combined into one housing located under the driver's seat (under carpet).
- Brake Pressure Sensor - The brake pressure sensor is installed in the hydraulic unit housing. This performs the same function as the previous hydraulic pressure sensor.

Control Module/ Hydraulic Unit

The control module used on the DSC III systems varies between models. The DSC III 5.3 system uses the same control module configuration at the ASC+T5 system.

The control module is an 83 pin unit located in the E-box.

The DSC III 5.7 system integrates the control module into the hydraulic unit. This reduces the size and wiring required for DSC operation. Additionally the motor relay and valve relay have been replaced by solid state final stages in the control module.

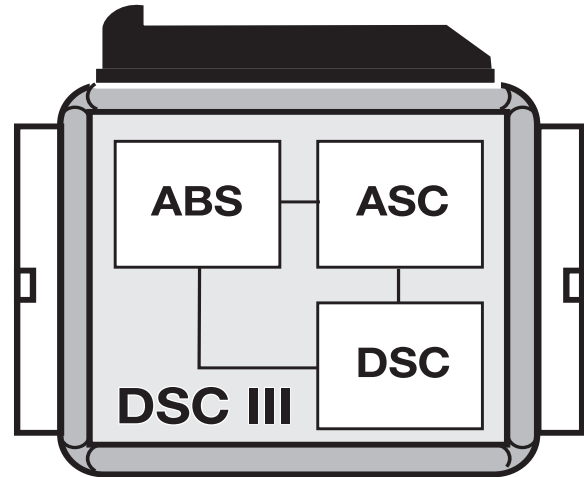

83 Pin Control Module Bosch DSC III 5.3

On E39 and E39 applications, the control module/hydraulic unit is located ahead of the passenger side strut tower. The hydraulic unit contains the following components:

- Two pre-charge solenoid valves
- Two changeover solenoid valves
- Four intake solenoid valves
- Four outlet solenoid valves
- One return pump



Control Module/Hydraulic Unit Bosch DSC III 5.7

Wheel Speed Sensors

The wheel speed sensors used are the same as on previous E38 and E39 models. The sensor is a hall effect type which sends a digital square wave to the DSC control unit. Unique to this sensor is the two wire versus three wire configuration as on most hall effect circuits.

The two wire hall effect wheel speed sensors receive a stabilized 8 volt power supply from the control module through one wire. The ground path for the sensor is through the second wire back to the control module.

The signal is generated by a pulse wheel affecting the voltage flow through the hall element in the sensor. The pulse wheel is integrated into the wheel bearing assembly, behind the seal. This protects the trigger wheel from foreign substances which may affect the wheel speed signal.

This creates a square wave signal with a low of .75 volts and a high of 2.5 volts.

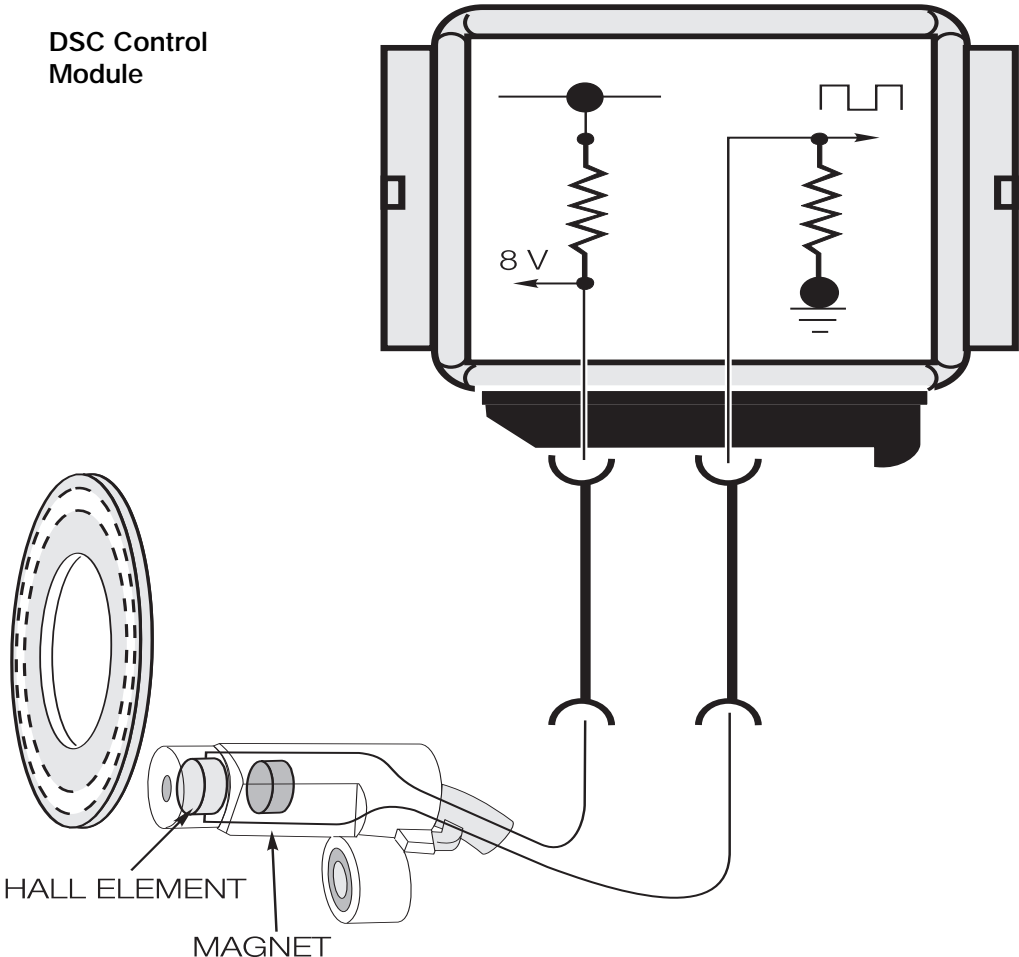

Hydraulic Pressure Sensor (Brake Pressure)

The hydraulic system pressure sensor provides a 0-5 volt linear voltage signal to the DSC III control module. The linear voltage is a proportionate indication of how hard the driver is pressing on the brake pedal. The signal is provided as an additional determining factor for the DSC III control module to monitor the hydraulic pressure present during all phases of operation, including:

- No Braking
- Partial Braking
- Near ABS regulation state.

The sensor has three pins, power, ground and the 0-5 volt signal. The sensor is capable of monitoring pressure from 0-250bar. The sensor is located in the front brake hydraulic circuit., the actual location varies by the following application:

- DSC III 5.3 (740i/iL and 540i) - The brake pressure sensor is located in the charge pump assembly.
- DSC III 5.3 (750iL) - The sensor is located on the charge piston unit.
- DSC III 5.7 (ALL) - The sensor is located on the hydraulic unit.



**Brake Pressure Sensor Location
Bosch DSC III 5.3 (740i/iL, 540i)**

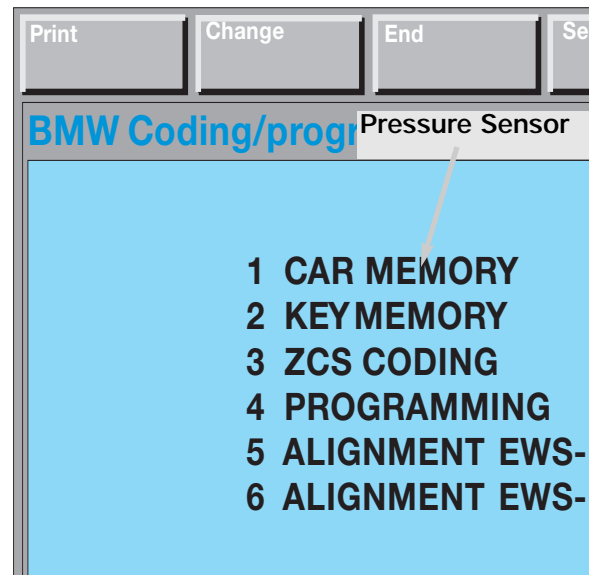

**Brake Pressure Sensor Location
Bosch DSC III 5.7 (All)**

Steering Angle Sensor

The steering angle sensor is mounted at the bottom of the steering column near the flexible coupling.

The sensor is a new type which differs from the DSC II system. This sensor is equipped with a processor and is directly linked to the CAN bus to communicate with the DSC module.

The sensor also contains the EDC III steering angle sensor in the same housing but it is not on the CAN bus and the signal output to the EDC III control unit remains unchanged.

The sensor still utilizes two potentiometers to determine the steering angle and the rate of steering angle change. These are the raw signals the CAN bus microprocessor utilizes to create the steering angle signal for broadcast over the CAN bus.

As with DSCII, this sensor still requires calibration after repairs to the steering or suspension system. Once the calibration is completed, the sensor now also sends an identification number over the CAN bus to the DSC III module. The ID provides confirmation to the DSC module that the steering angle sensor is properly calibrated.

If the ID differs due to component swapping, it will not be possible to enter the DSC system for diagnosis. The Diagnosis Program will request that the steering angle sensor be recalibrated using "Service Functions". Once complete, a new ID number is generated and the DSC module and steering angle sensor are properly mated.

The DSC III logic checks the plausibility of the steering angle sensor against other DSC III inputs (front wheel speeds, rotation rate and lateral acceleration sensors). If the battery voltage is interrupted, the current steering wheel rotation is recalculated by the DSC module evaluating front wheel speeds.

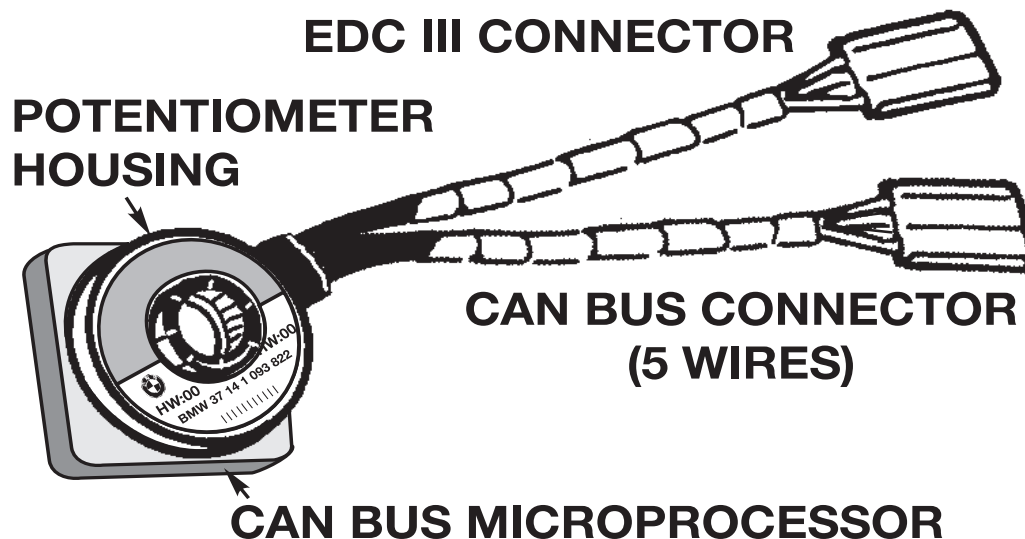

Rotation Rate Sensor (Bosch 5.3)

The new sensor is a major contributor of the expanded capabilities of DSC III. When the rotation rate sensor was introduced with DSC III 5.3, the sensor was a stand alone sensor located under the drivers seat. On DSC III 5.7, the sensor is now a combined sensor which also houses the lateral acceleration sensor.

To access the sensor, the seat must be removed, the door jamb interior trim pulled out of the way and the carpet rolled back. A sound insulating foam shell covers the sensor, this too must be pulled upward off of the sensor prior to removal.

Sensor Operation

The sensor is a sealed, self contained microprocessor that monitors the vehicle's rate of rotational acceleration on it's vertical axis. This is referred to as the "yaw" angle. The sensor contains an internal oscillating cylinder which is excited by various piezo elements to an oscillation frequency of 14KHz. This puts the cylinder in a free floating neutral state. (zero point)

When driving, the cylinder is deflected (rotated) by the effect of the forces from the vehicle cornering - this produces the torsional "twist" on the cylinder.

The sensor counteracts the "twist" of the cylinder by increasing the pulse frequency of the piezo elements to deflect the cylinder back to it's zero point.

The pulse frequency increase in measured and represent the real time vehicle rotation rate. Based on the measurement, the sensor produces a linear DC voltage that the DSC III control module uses to determine yaw angle.

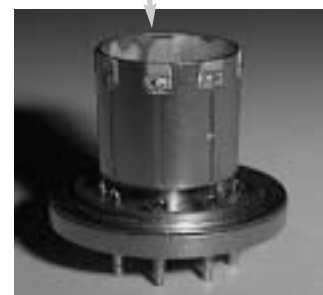
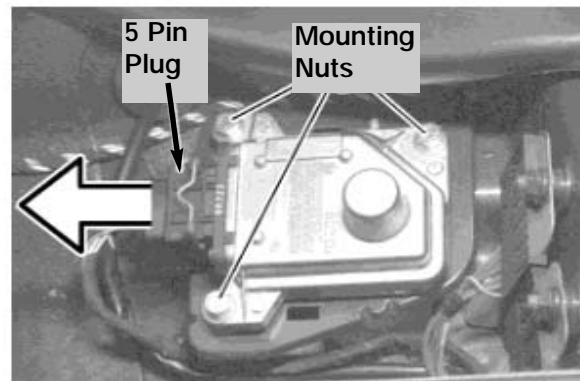
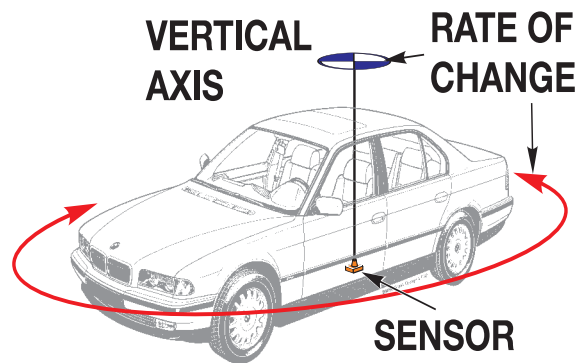

Rotation Rate Sensor Signals

The DSC III control module provides the rotation rate sensor with 12 volts operating power and ground. In return, the sensor provides:

- A standing 2.5 volt reference voltage signal (pin 4 of sensor)
- A linear voltage signal ranging from 0.7 to 4.3 volts (pin 3 of sensor)

The linear voltage equates to a range of -50° (.7V) to $+50^{\circ}$ (4.3V) vehicle rotation rate change per second. The DSC III control module monitors the signal voltage every 20ms.

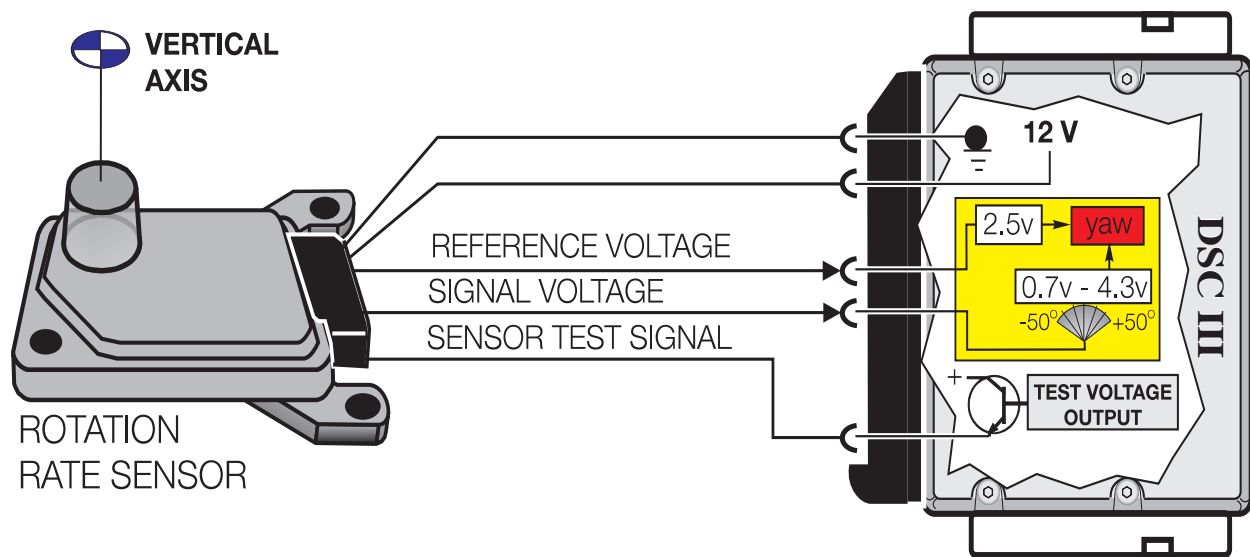

In conjunction with the steering angle, front wheel speeds and lateral forces, the rotation rate signal provides confirmation of a vehicle pushing the limits of acceptable yaw. The DSC III control module then regulates the torque output of the vehicle and manipulates the brake system hydraulics as needed to correct for the under/oversteer condition.

For continual plausibility testing, the DSC control module send a predetermined test voltage signal to the rotation rate sensor (pin 5 of sensor). The sensor calculates the voltage value and sends feedback to the DSC III control module over the signal line (pin 2) every other 20ms signal cycle. If the feedback is out of plausible range the DSC III module sets a fault.

The DSC III module also checks the actual signal for plausibility by comparing it to combined signals from the front wheel speed sensors, lateral acceleration sensor and the steering angle signal from the CAN bus.

Sensor Replacement

If the rotation rate sensor is replaced, the new sensor must be calibrated with the DSC III control module through the Service Function Menu of the Diagnosis program using the DISplus or GT-1.

Lateral Acceleration Sensor (Bosch 5.3)

This new sensor is a major contributor of the expanded capabilities of DSC III.

It is located under the drivers seat but mounted on the vertical surface of the inner rocker sill. (approximately 2" in front of the B pillar).

The drivers seat and door jamb trim must be removed and the floor coverings pulled out of the way to access the lateral acceleration sensor.

Sensor Operation

The lateral acceleration sensor is connected to the DSC III control module by a 3 pin plug. The sensor receives operating power and ground. In return, it provides a linear voltage signal which is a measurement of "side to side" G-force acceleration.

- The voltage range is from 0.5 to 4.5 volts which corresponds to a G force range of -1.5 to +3.5 g.
- With the vehicle stationary on a level surface, approximately 1.7 volts is present on the signal line. This is indicative of the nominal value of 0.0g.

The sensor is a capacitive type sensor. Under the effects of lateral acceleration, a moving capacitor plate moves in relation to a fixed capacitor plate. The result is a signal proportional to the effect of lateral acceleration.

The signal provides additional information which enables the DSC III logic a higher level of sensing the vehicles handling characteristics.

The DSC regulation is calculated from:

- The steering input from the desired vehicle direction from the driver
- The Rotation Rate sensor to determine the "yaw" of the vehicle
- The left and right front wheel speed to verify the turning rate in the corner

These inputs allow the DSC logic to calculate the under/over steer while cornering, and the rate of the vehicle speed entering the corner. For this calculation, the DSC can then compensate by reducing engine torque, and applying the appropriate braking to stabilize the vehicle for safer handling.

RATE OF CHANGE IN SIDE-TO-SIDE MOVEMENT (LATERAL ACCELERATION)

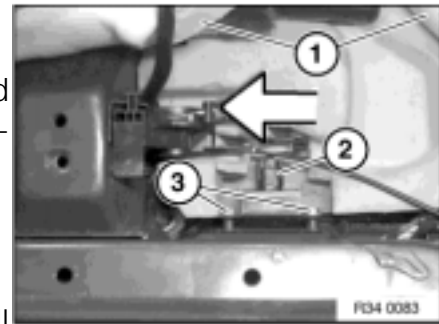
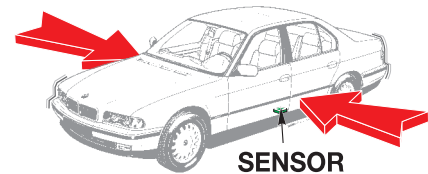

**1 - Floor Covering 2 - 3 Pin Plug
2 - Mounting Screws**

Combined Rotation Rate/Lateral Acceleration Sensor (Bosch DSC III 5.7)

On DSC III (Bosch 5.7) the Rotation Rate sensor and the Lateral Acceleration sensor have been combined into one unit. The sensor is located under the driver's seat and it is smaller in size and weight and is isolated from chassis vibrations through its rubber mounting.

The sensor provides the same information as the two separate sensors used on DSC 5.3. It receives the same power and ground from the DSC control module.

For rotational speed, the sensor produces a reference signal of 2.5 volts and a linear voltage from 0.7 to 4.3 volts. This linear voltage input signal is used by the DSC control module as the degree of rotational rate (yaw).

The sensor also produces a linear voltage signal from 0.5 to 4.5 volts. The DSC control module used this input to determine the side forces acting on the vehicle for DSC regulation.

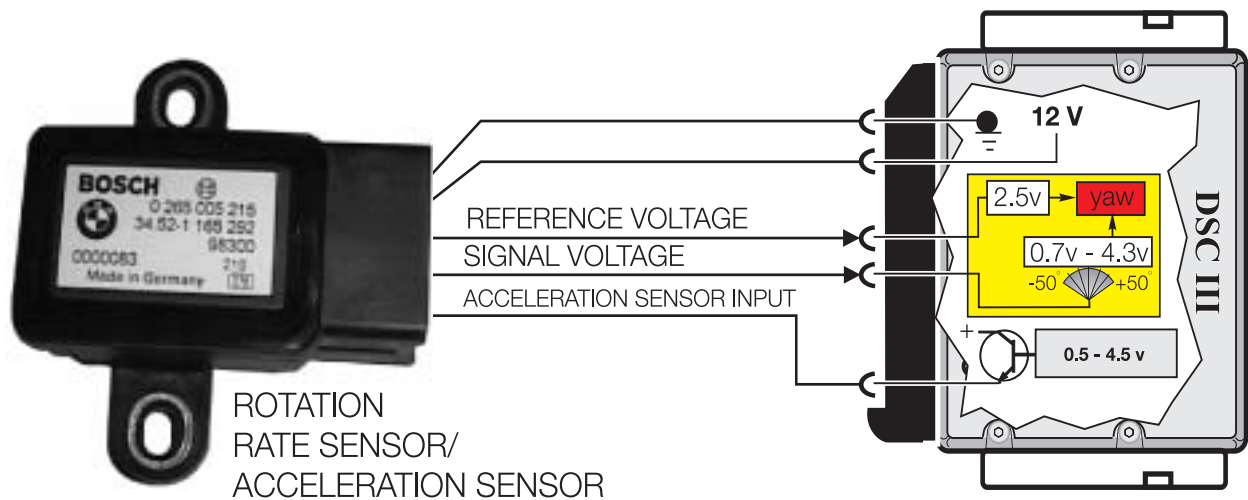

DSC Switch

The system is active whenever the ignition is switched on. When pressed, the switch provides a momentary 12 volt signal to the DSC control module to switch the system off. The DSC indicator in the cluster will be illuminated to indicate that the system is off. When pressed again, the system switches back on and the DSC indicator goes off.

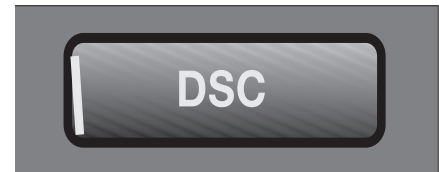

Handbrake Switch

The handbrake switch is a ground input the DSC module. MSR regulation is cancelled when there is a "Handbrake On" signal present.

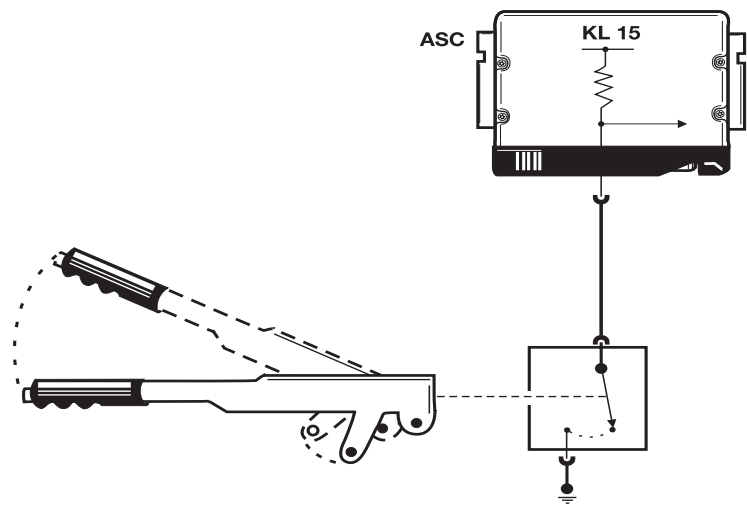

Brake Switch

The brake switch is used to activate the ABS functions in the DSC III module. If the system receives a brake switch signal when in ASC mode and regulating, ASC regulation is cancelled.

The ABS regulating phase is also cancelled when the brake switch signal is not present.

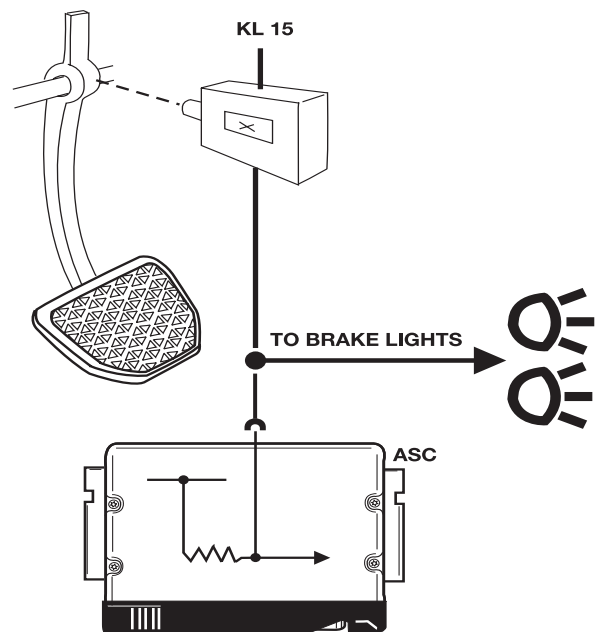

DSC III (BOSCH 5.3) Hydraulic System Components

As mentioned at the beginning of this section, there are minor differences in the hydraulics for the 750iL compared with the 740i/iL and 540iA. The following components are the same for either variation of the system:

Hydraulic Unit:

- Similar to DSC II hydraulic unit
- Modulates brake pressure during ABS, CBC, ASC and DSC control procedure.
- Contains:
 - 1 pump motor,
 - 2 return reciprocating pumps
 - 2 preload valves,
 - 2 changeover valves
 - 2 accumulator chambers
 - 2 damper chambers
 - 4 inlet valves
 - 4 outlet valves

Master Cylinder:

Master cylinder, fluid reservoir and level switch. All new components.

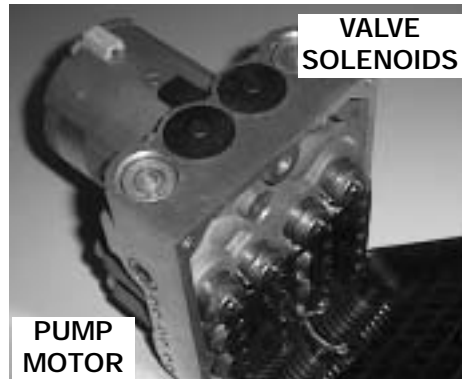
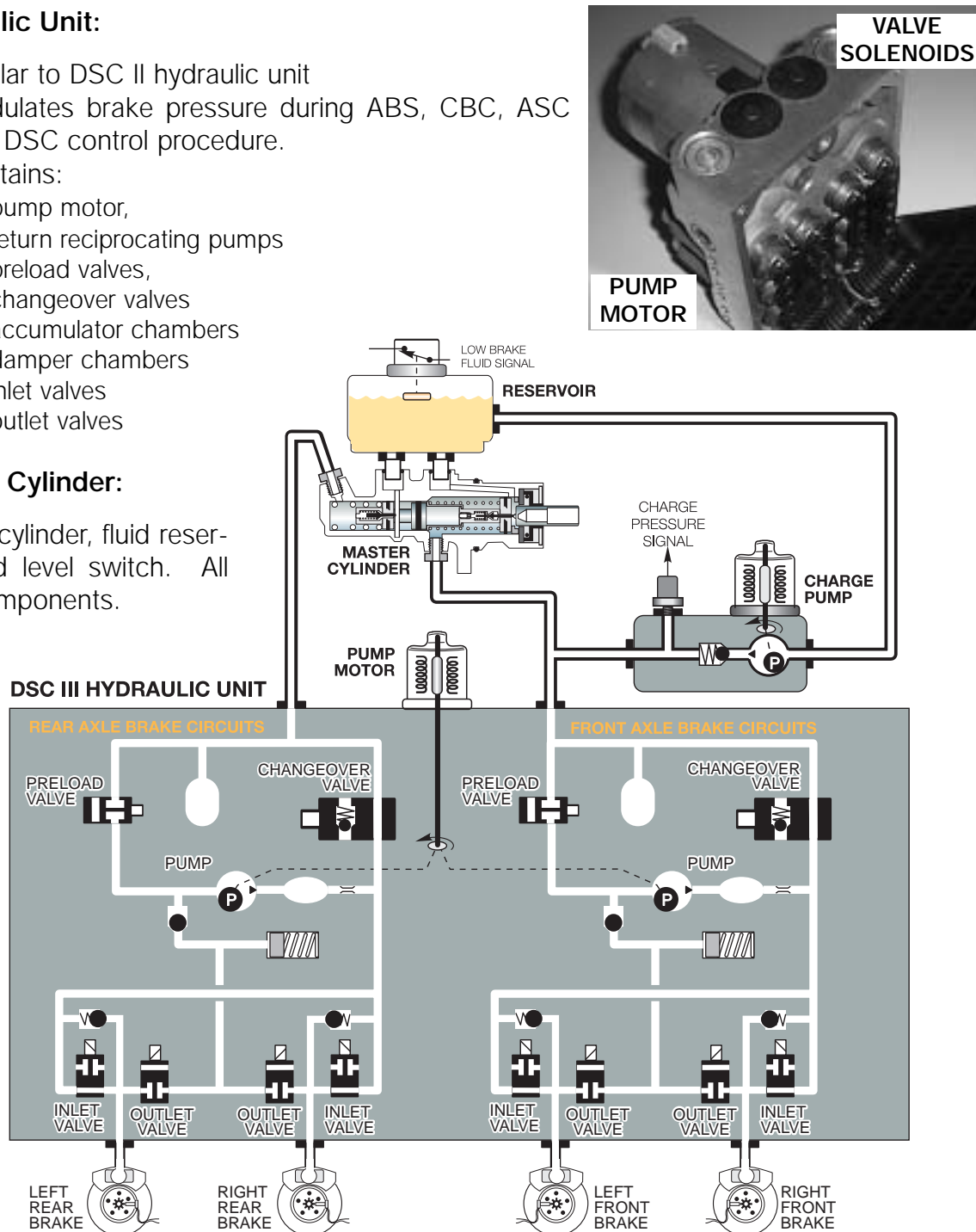

To ensure sufficient brake fluid supply is always available to the hydraulic unit during ASC/DSC hydraulic regulation, the system requires an additional pumping system not equipped on any previous ASC+T system.

The pumping systems are different on the 750iL compared with the 740i/iL & 540iA and are as follows:

- **740i/iL & 540iA = Charge pump** - located next to the master cylinder.
- **750iL = Pre-boost pump** and separate **charge piston**. These components are also mounted next to the brake fluid master cylinder and fluid reservoir.

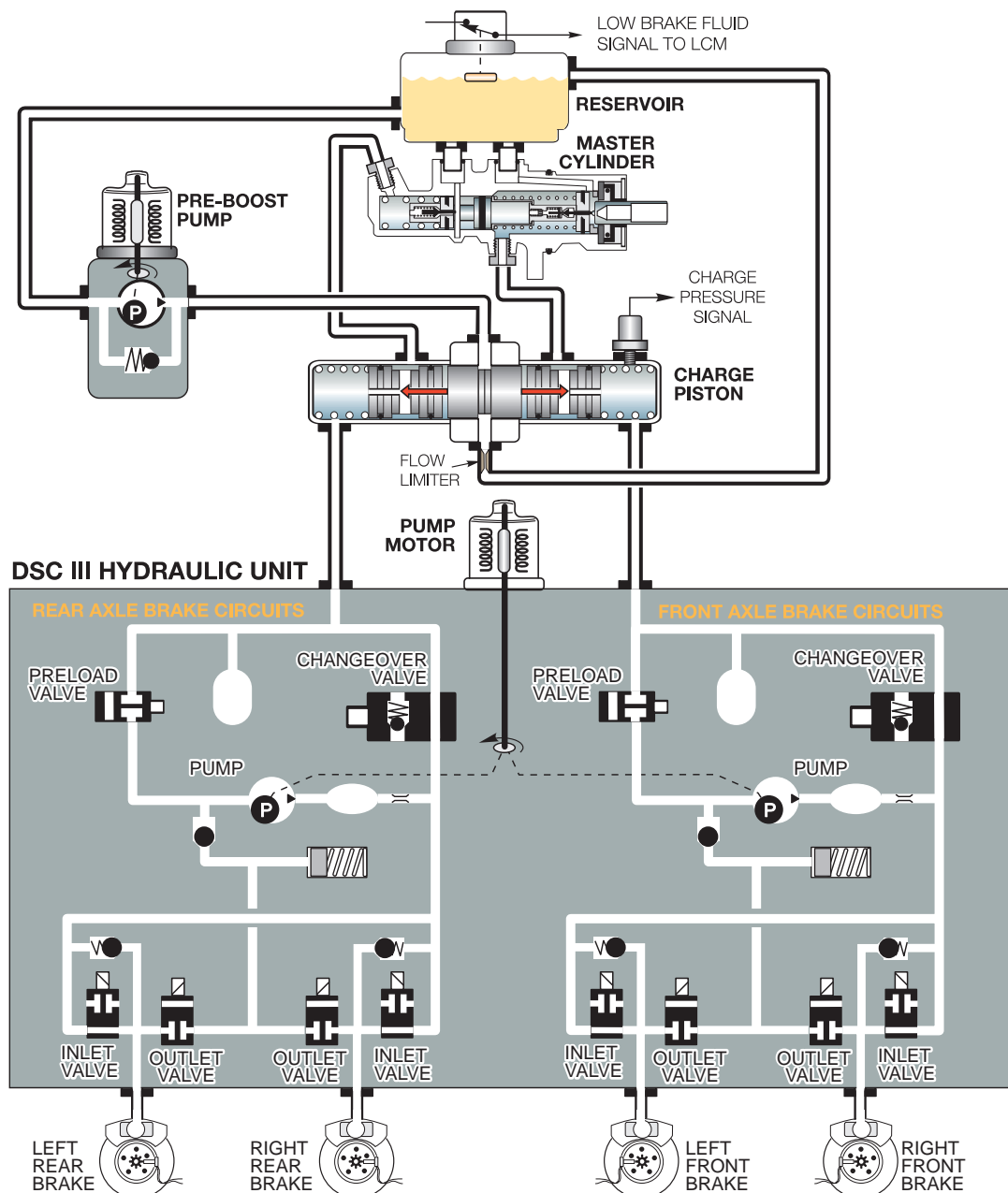

Hydraulic Charge

Existing ASC+T and DSC II systems already perform hydraulic control regulation but do not require the additional charge pump systems. Why? The reason being those systems only actuate the rear axle circuits. Obviously, the DSC III system has the capability to actuate front and rear axle circuits together which requires additional hydraulic fluid supply.

For this reason, during an **ASC or DSC regulation** function requiring hydraulic intervention, the DSC III control module switches the electrical charge pump on to provide this additional fluid.

740i/iL & 540iA Vehicles:

When activated, the Charge Pump delivers a brake pressure of 10 - 15 bar to the front axle circuit of the hydraulic unit and into the front axle circuit pressure chamber of the master cylinder. The master cylinder piston for the front axle circuit contains a notched restrictor forward of the central valve which allows excess fluid to return to the reservoir under a restriction.

The pressurized fluid also acts on the rear axle circuit of the master cylinder. This provides the hydraulic charge to the rear axle circuit of the hydraulic unit as needed.

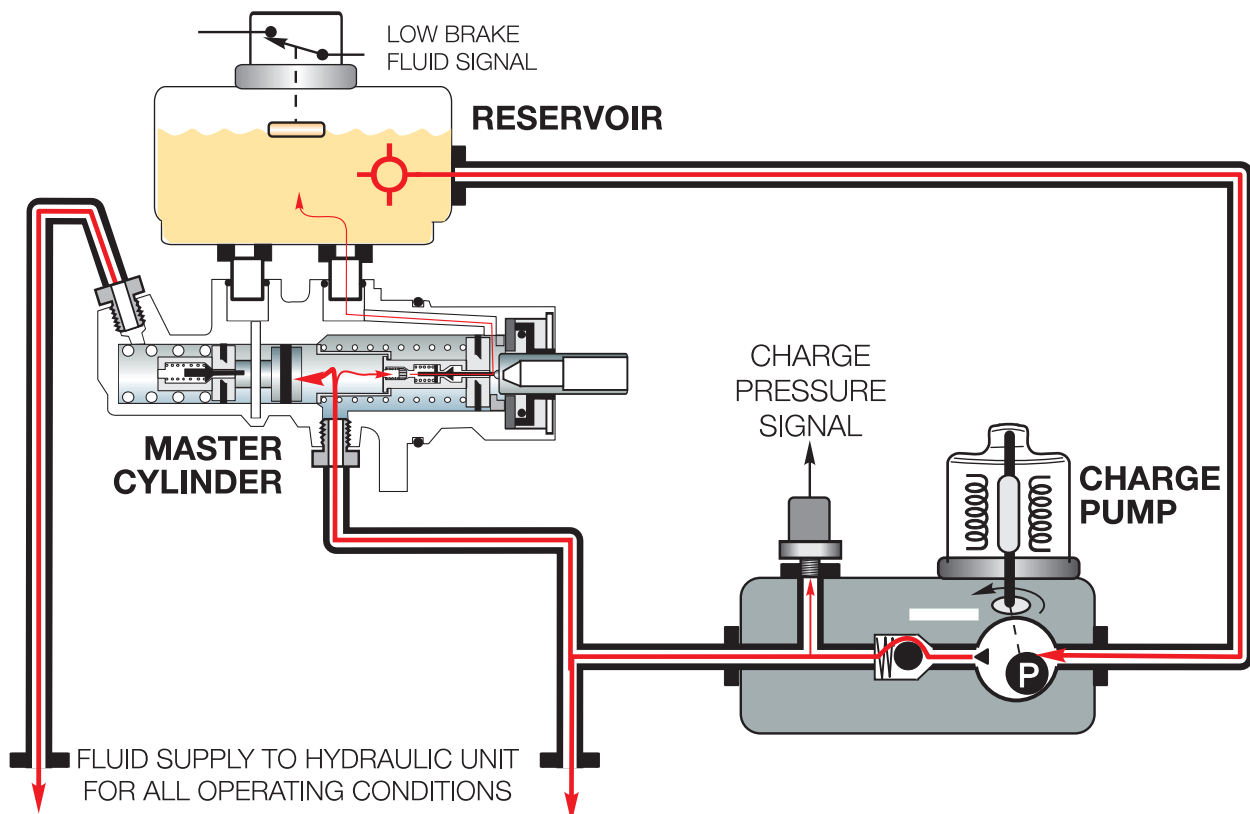

750iL Vehicles:

The electric **Pre-boost pump** delivers a brake fluid pressure of 7-15 bar to the isolated chamber of the **charge piston**. The pre-boost pump incorporates an integral pressure relief valve which opens at 15 bar.

From the isolated chamber the fluid returns to the reservoir through a restriction. The restriction causes pressure to build in the chamber which pushes the pistons outward. This immediately acts on two valves which block the normal braking circuits that flow through the charge piston ports.

The pressure in the isolated chamber continues to push the pistons outward delivering the required charge pressure.

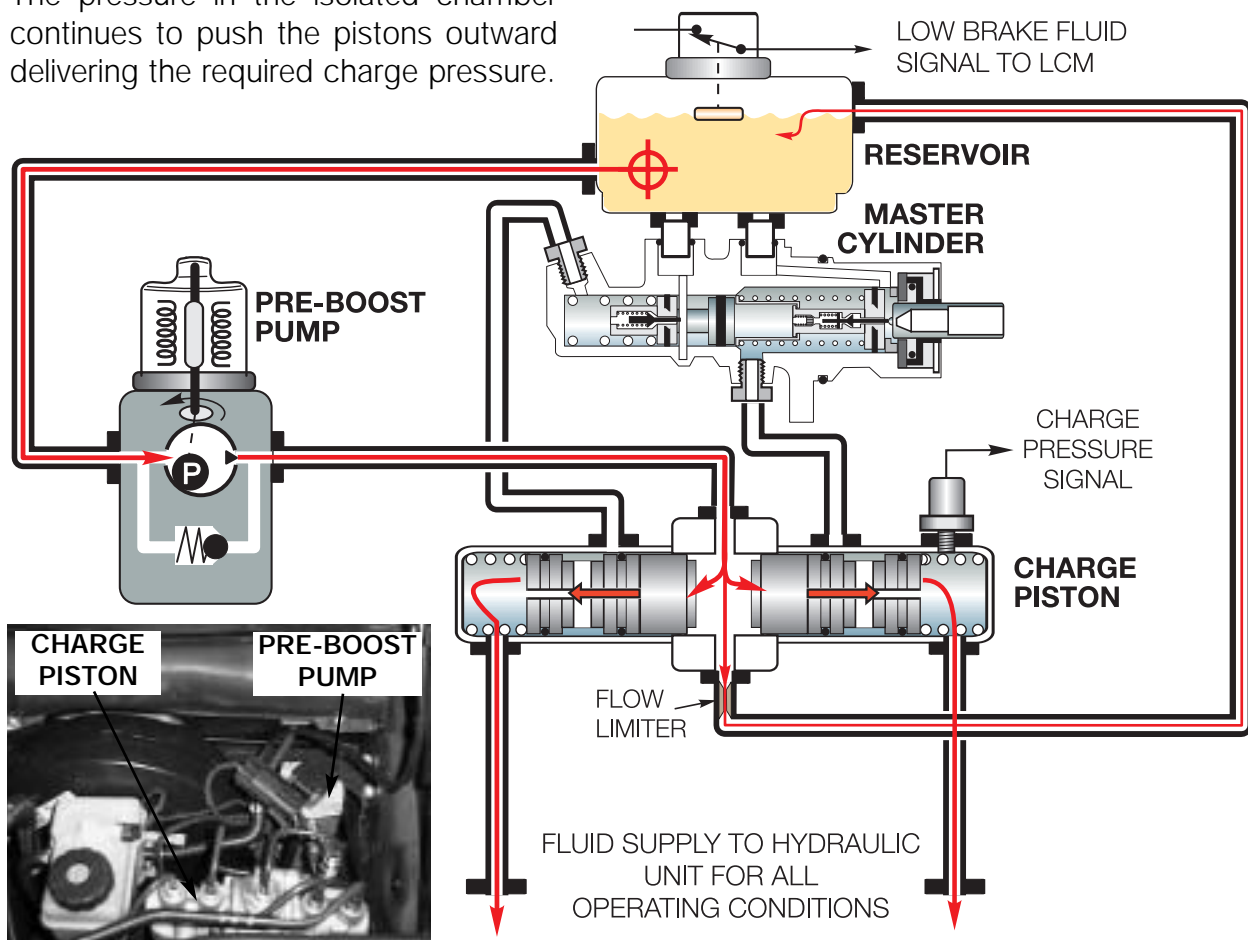

For ABS and CBC operation, the pump systems are **not** switched on, only during ASC/DSC regulation requiring hydraulic intervention are the pre-boost pump or the charge pump switched on. The balance of the hydraulic system functions operate in the same familiar manor of all previous systems. The individual brake circuits can be isolated as needed to restore lateral locating forces through pressure build, hold and release phases of operation. During an ASC hydraulic intervention requiring only rear wheel brake application, the inlet valves for the front wheels are closed preventing any pressure influence from the charge pump systems.

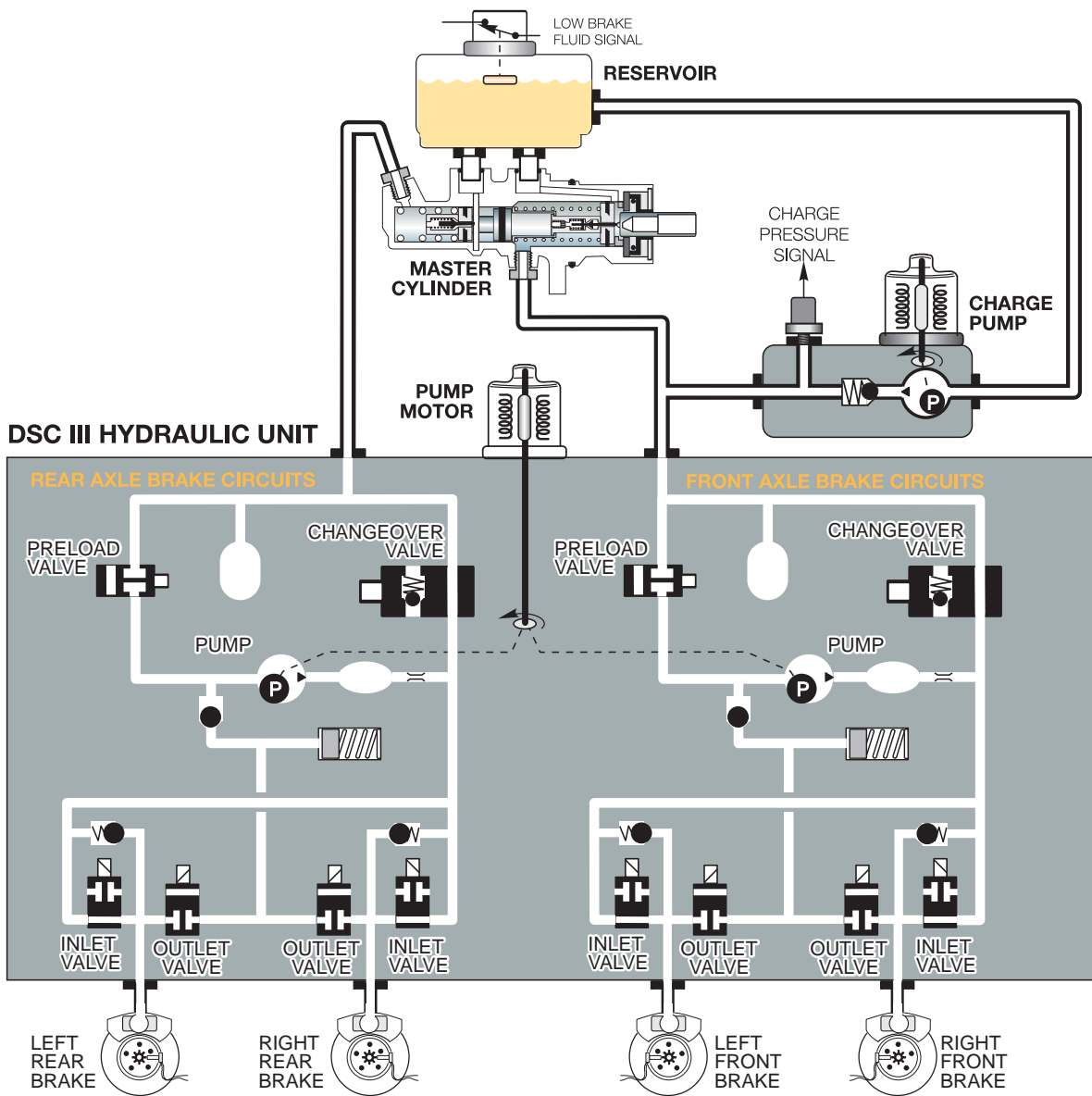

Principle of Operation

Dynamic Stability Control Systems

Introduction

Dynamic Stability Control (DSC III version 5.3) was introduced on the 1998 Model Year E38 and E39 - 540 vehicles. For Model Year 1999, the system is enhanced with additional control functions and a new combined rotational rate/lateral acceleration sensor as version 5.7. It continues to be offered as standard equipment in the E38 and E39 - 540 models. The new functions are titled as the Dynamic Braking System and include the:

- Dynamic Brake Control (DBC)
- Maximum Brake Control (MBC)

DSC III adds a further dimension to the dynamic stability control system. DSC II has the ability to mildly correct for lateral instability and only at the rear brakes when braking control is necessary. DSC III has the ability to brake any wheel during cornering maneuvers where the control module's programmed limits for vehicle oversteer and understeer are exceeded.

New sensors are added to the DSC III system to monitor the rotational rate of the vehicle around its vertical axis and a lateral acceleration sensor to monitor the side to side forces on the vehicle.

The hydraulic system of the DSC II has also been modified to allow brake regulation on the front wheels and to ensure that the supply of brake fluid for DSC II regulation is maintained.

Two different hydraulic systems are used on the Bosch 5.3 DSC system as follows:

- 740i/iL & 540iA use a charge pump for the front brake circuit.
- 750iL uses a boost pump and separate charge piston for both the front and rear brake circuits.

The hydraulic system used on the Bosch DSC III 5.7 has changed on the E38 and E39. The 750iL now uses a similar hydraulic system to the 740i/iL and 540i. The charge piston and pre-boost pump have been eliminated. The brake pressure sensor is now located in the hydraulic unit on all Bosch 5.7 systems.

Dynamic Stability Control (DSC III)

All of the familiar braking and straight line traction control features and system communication carry over from DSC II. Based on select high/select low logic, the DSC III control module selects a vehicle stabilizing strategy based on the specific input signal values it is monitoring at the moment. For all DSC strategies this begins with engine intervention to reduce torque:

- For the 750iL this is handled via CAN communication, DSC III to EML to minimize the throttle angle of the DK motors (750iL). For the 740i/iL and 540iA this is handled by direct DSC III activation of the ADS II throttle housing.
- If additional torque reduction is necessary, DSC III informs DME over CAN to:
 - a. Retard ignition timing
 - b. Shut down the fuel injection to individual cylinders

DSC III monitors under/oversteer conditions through the following components:

- The driver's desired steering angle - steering angle signal over CAN bus.
- Vehicle speed and speed differential at front wheels - wheel speed sensors
- Dynamic forces of lateral acceleration and yaw placed on the vehicle. This is possible with these two new components. The results are as follows:

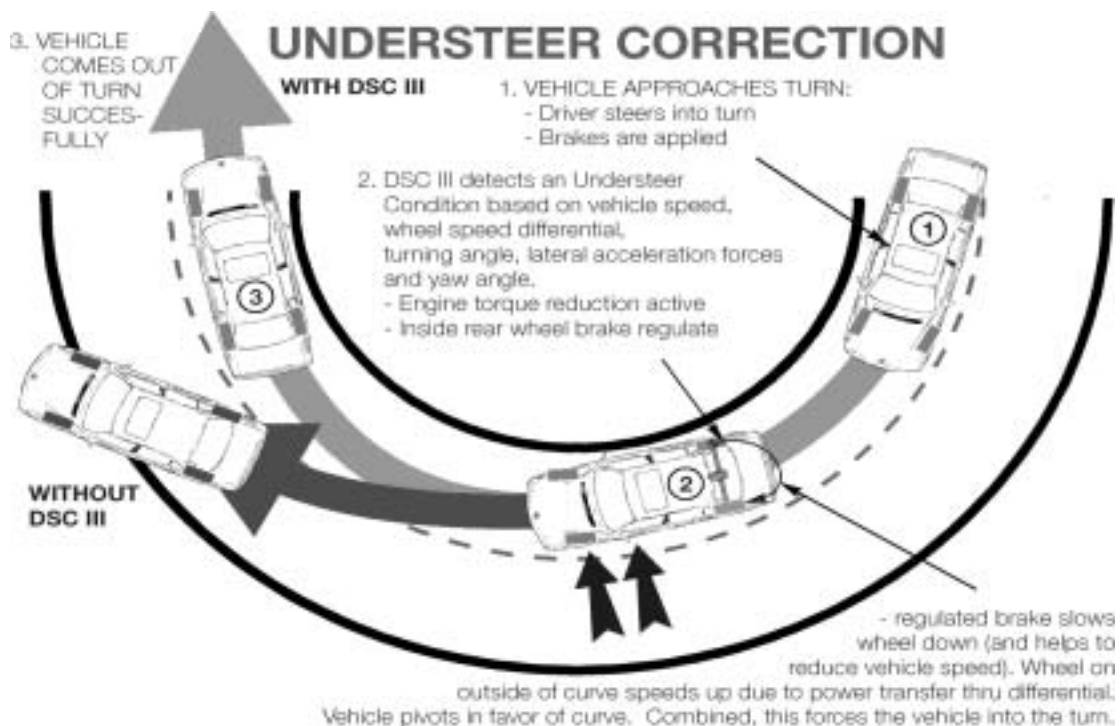

The expanded hydraulic control of individual wheel circuits is apparent when stabilizing a vehicle exhibiting an oversteer condition as follows:

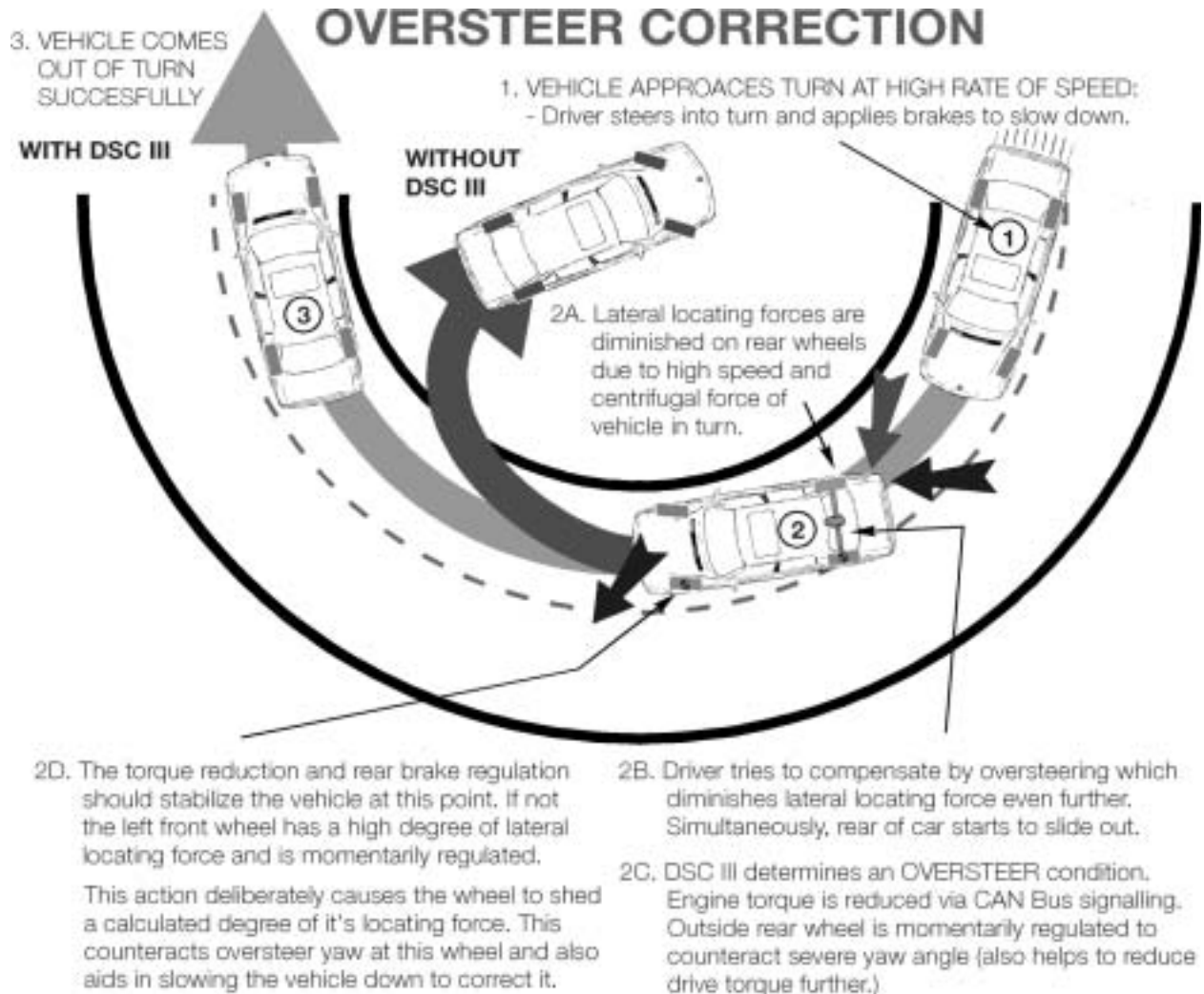

Transmission system intervention also occurs during any ASC/DSC regulating phase. Through CAN bus communication the AGS control module is informed to delay any gear changes during regulation. This prevents any unwanted driveline dynamic changes during DSC regulation.

Though DSC III provides state of the art, electronic correction of undesirable vehicle handling characteristics, it is important to remember vehicle stability is always subject to the physical laws of centrifugal force and extreme road conditions. **Good judgement and common sense on the part of the driver are still required.**

DSC Features

Corner Braking Control (CBC)

CBC is a feature of dynamic stability control that is designed to improve the vehicle's stability if the driver brakes while driving through a curve. If the vehicle is braked while driving through a curve, an unequal braking force will be applied to the wheels due to the weight shift of the vehicle to the outside of the turn. Based on the vehicle speed and the speed differential of the two front wheel speed sensors, the control module can determine if CBC needs to be activated when the driver applies the brakes. If CBC is activated, the regulation will pulse the wheel brakes on the outside of the vehicle to provide an equal braking force on all four wheels.

Dynamic Braking System (DBS)

The dynamic braking system is designed to enhance the braking control of the DSC for the driver of the vehicle. The dynamic braking control and maximum braking control are functions that are programmed into the control electronics of the DSC with no additional hardware changes. The Dynamic braking system features consist of DBC and MBC.

Dynamic Braking Control (DBC)

The DBC function is designed to provide the maximum braking force available during rapid (panic) braking situations. The DSC control module looks at the inputs from the brake pedal switch and the signal from the brake pressure sensor on the master cylinder. The criteria for activation of DBC is how rapidly is the brake pressure built up with the brake pedal depressed. The total criteria required for DBC activation includes:

- Brake switch ON
- Brake pressure build up > threshold value
- Vehicle road speed > 5MPH
- Vehicle not in reverse
- Not all wheels in ABS regulation

If the threshold for DBC activation is achieved, the DSC control module will activate a pressure build up regulation phase through the hydraulic unit. The pressure at all wheels is increased up to the ABS regulation point. This occurs even if the driver does not achieve the ABS regulation point with the pedal.

The rear axle brakes are controlled with select-low regulation and the front axle brakes are controlled individually. ABS regulation will continue until the driver releases the pedal and the pressure in the master cylinder drops below the threshold value stored in the DSC control module.

Maximum Brake Control

The MBC function is also designed to enhance a driver initiated braking procedure. The MBC will build up the pressure in the rear brake circuit when the front brakes are already in an ABS regulation cycle. The additional braking pressure at the rear wheels will shorten the stopping distance. The following criteria must be met before the DSC control module will activate MBC:

- Both front wheel brakes in ABS regulation
- Vehicle speed > 5 MPH
- Vehicle not in reverse
- DBC and pressure sensor initialization test OK
- Rear wheels not in ABS regulation

Diagnosis

The following diagnostic functions are available using the DISplus or GT-1.

Control Unit Functions:

Expert mode diagnosis available at any time during troubleshooting. To enter: press the Control Unit Functions button at the right lower corner of the screen.

The contents are:

- **Identification**
- **Delete Fault Memory**
- **Read Fault Memory**
- **Component Activation**
- **Status queries (requests)**

Service Functions:

Provides access to specialized test modules used as post repair procedures. To enter:

- Function Selection
- Service Functions
- Chassis
- Dynamic Stability Control

The contents are:

- **Connection Speed Sensor:** A test to verify the proper wiring to the wheel speed sensors
- **Connection Brake Lines:** A test to verify the proper brake pipe connections to the hydraulic unit.
- **Adjustment Functions:** Test modules to initialize certain components after repair work is performed
 - Steering Angle Sensor
 - Lateral Acceleration Sensor
 - Pressure Sensors

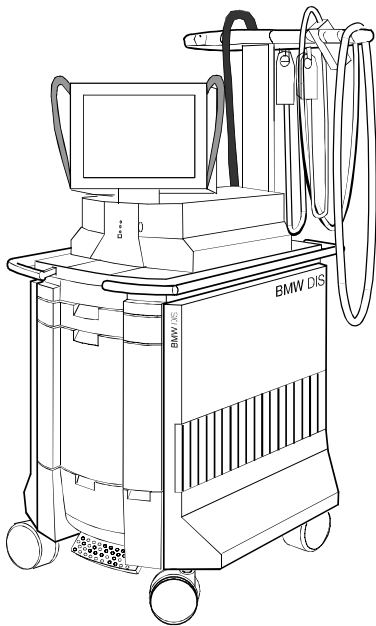

Test Modules: Faults with the DSC III system can be diagnosed using fault or symptom driven test modules. To begin diagnosis:

- **Perform the Quick Test.**
- **Select Vehicle Symptom from the Symptom Selection page.**
- **Select Test Module from Test Plan page.**
- **Press the Test Schedule Button.**

Coding

Coding must be performed after replacement of the DSC III control module or the steering angle sensor. ZCS coding is found in the Coding and Programming selection from the start screen or when pressing the Change button. Follow on-screen instructions for initialization of components after completing the coding process.

Adjustment Functions

Adjustment (initialization) is required when:

- Replacing the DSC III Control Unit.
- Replacing/Re-coding the Steering Angle Sensor.
- Replacing one or both Brake Pressure Sensors.
- Replacing Lateral Acceleration Sensor.

Steering Angle Sensor

The steering angle sensor requires an offset adjustment after the sensor has been replaced, coded or after repairs to the steering or suspension system. The offset adjustment informs the steering angle sensor processor of the straight ahead position of the front wheels.

The adjustment is performed by completing the Test Module found in Service Functions. Once the adjustment is complete the sensor sends an identification number over the CAN bus to the DSC control unit. The ID provides confirmation that the steering angle sensor is coded and has successfully completed the adjustment procedure.

Special Tools

Special Tools available for the DSC III system consist of:

Tool #	Description	Purpose
34 5 240	42 Pin V-Cable	For B.O.B. 61 4 390
61 4 390	60 Pin B.O.B.	For pin by pin diagnosis
34 5 160	Pressure Sensor Socket	For installation and removal of hydraulic brake pressure sensor.
61 4 420	83 Pin B.O.B.	For pin by pin diagnosis of Bosch DSC III 5.3 and ASC +T5

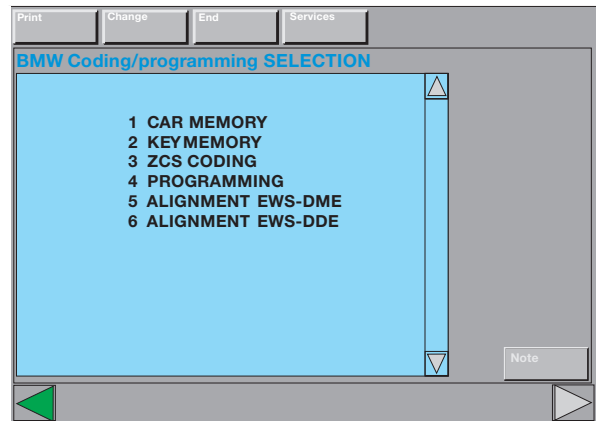

Review Questions

1. What are the primary differences between Bosch 5.3 and 5.7?

2. What is the nominal voltage output of the Rotation Rate sensor when the vehicle is at rest?

3. What type of wheel speed sensors are used on the Bosch DSC III system on the E38 and E39?

4. List the required activation criteria for DBC activation:

5. List the required activation criteria for MBC activation:

Review Questions

6. What hydraulic components are unique to the 750iL with DSC 5.3?

7. What 2 DSC component are responsible for the increased dynamic control of DSC III over DSC II?

8. List the locations of the hydraulic pressure sensor on the following DSC systems:

DSC 5.3 (740i/iL and 540i) _____

DSC 5.3 (750iL) _____

DSC 5.7 (All) _____

9. Briefly explain Corner Braking Control (CBC):

10. What is the handbrake signal input used for on DSC III?
